

GSA PRODUCT CATALOG

2024



LifeFitness

**HAMMER
STRENGTH®**



Contract Holder

Contract GS-03F-120DA

Life Fitness Sales, Inc.

10601 Belmont Ave, Franklin Park Illinois, 60131

TELEPHONE:

Toll Free: 800.494.6344

Direct: 847.288.3440

Fax: 847.789.8506

EMAIL:

MilitarySales@LifeFitness.com

WEBSITE:

LifeFitness.com

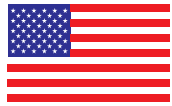

Federal Supply Schedule 78

Contract Number: **GS-03F120DA**

Contract Period: **June 2016 – June 2026**

Central Contractor Registration: **Registered**



AS THE NO. 1 BRAND OF FITNESS EQUIPMENT WORLDWIDE, HELPING PEOPLE ACHIEVE THEIR FITNESS GOALS IS OUR FOCUS.

For 50 years, it's been a commitment that has set us apart. Our world-class equipment is designed to meet every exercise need regardless of fitness level, from beginner to military elite.



TABLE OF CONTENTS

LIFE FITNESS CARDIO

Integrity+ Cardio	4
Aspire Cardio	8
Activate Series	12

GROUP TRAINING

Heat Row & SPARC	15
ICG	16
SYNRGY180	20
SYNRGY360	22
SYNRGY90	23

LIFE FITNESS STRENGTH

Insignia Series	26
Signature Series	28
Axiom Series	34
Studio Collection	36

HAMMER STRENGTH

HD Performance Trainers	40
Hammer Strength Select	42
MTS	44
Plate-Loaded	46
Ground Base	49
HD Elite iD	51
HD Athletic	54
HD Athletic NX	55
HD Athletic Pro	56
Benches & Racks	62

ACCESSORIES

Hammer Strength	64
Life Fitness	68
ACFT	70

Support

Service	72
Color Chart	73

LifeFitness

INTEGRITY+

INTEGRITY+ CARDIO

Cardio built to be reliable, effective, aesthetically pleasing and inviting for any exerciser.



TREADMILL

Integrity+ with Discover SE4 Console, Smooth Charcoal / INT-SE424

Other options:
Treadmill with SE4 Console (24") / INT-SE424
Treadmill with SE4 Console (16") / INT-SE416
Treadmill with SL Console / INT-SL



ELLIPTICAL CROSS-TRAINER

Integrity+ with Discover SE4 Console, Smooth Charcoal / INX-SE424

Other options:
Elliptical with SE4 Console (24") / INX-SE424
Elliptical with SE4 Console (16") / INX-SE416
Elliptical with SL Console / INX-SL



UPRIGHT LIFECYCLE EXERCISE BIKE

Integrity+ with Discover SE4 Console, Smooth Charcoal / INC-SE424

Other options:
Upright with SE4 Console (24") / INC-SE424
Upright with SE4 Console (16") / INC-SE416
Upright with SL Console / INC-SL



RECUMBENT LIFECYCLE EXERCISE BIKE

Integrity+ with Discover SE4 Console, Smooth Charcoal / INR-SE424

Other options:
Recumbent with SE4 Console (24") / INR-SE424
Recumbent with SE4 Console (16") / INR-SE416
Recumbent with SL Console / INR-SL



POWERMILL CLIMBER

Integrity+ with Discover SE4 Console, Smooth Charcoal / INPM-SE424

PowerMill with SE4 Console (24") / INPM-SE424
PowerMill with SE4 Console (16") / INPM-SE416
PowerMill with SL Console / INPM-SL



ARC TRAINER

Integrity+ Total Body Arc Trainer with Discover SE4 Console, Smooth Charcoal / INA-TSE424

Other options:
Total Body Arc Trainer with SE4 Console (24") / INA-TSE424
Total Body Arc Trainer with SE4 Console (16") / INA-TSE416
Total Body Arc Trainer with SL Console / INA-TSL
Lower Body Arc Trainer with SE4 Console (24") / INPA-LSE424
Lower Body Arc Trainer with SE4 Console (16") / INPA-LSE416
Lower Body Arc Trainer with SL Console / INA-LSL

INTEGRITY+ CARDIO CONSOLES

CONSOLE OPTIONS

Choose from the immersive experiences provided by the Discover SE4 Console (available in 24" and 16" sizes) or the get-on-and-go functionality of the SL Console.



SL CONSOLE*

Rethink LED.

LED consoles don't have to be a commodity. Advancement in exerciser interaction like Apple Watch® compatibility and Bluetooth® connections are built into the Integrity SL console.

Up to 22 workouts feature several fitness tests, including those used by the Army, Navy, Marines and Air Force.

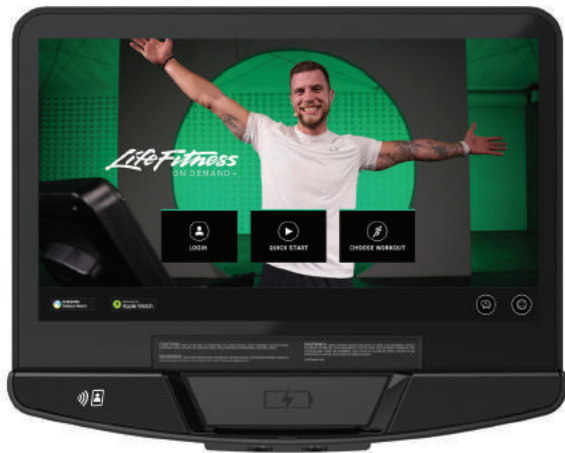

DISCOVER SE4 CONSOLE

The state-of-the-art console has a large 24" screen (16" also available) available across all base types for an immersive experience and access to hundreds of workouts through Life Fitness™ On Demand+.

The visually rich 1080p touch screen employs cutting-edge AIT technology for an incredibly responsive user interface. Exercisers can seamlessly sync a smartphone, tablet or other device using Bluetooth® or NFC technology and the console offers convenient wireless phone charging.



* Enhance entertainment with an attachable TV (Available for SL Console Only)



INTEGRITY+ BASES

Premium cardio that includes enhanced aesthetic touches, a choice of Black Onyx, Smooth Charcoal Titanium Storm, Arctic Silver or Diamond White finishes and the following equipment-specific features.

TREADMILLS

Remote speed and incline controls, and Flex Deck Shock Absorption Technology to reduce impact.

CROSS-TRAINERS

Remote resistance controls on multi-grip handles, rounded FlexForm pedals

UPRIGHT BIKES

Remote resistance controls on the handlebars, comfortable handlebar elbow pads, self-leveling pedals

RECUMBENT BIKES

Deluxe comfort seat, remote resistance controls on the side handles, exerciser-assist handles, self-leveling pedals



UPRIGHT LIFECYCLE EXERCISE BIKE WITH SL CONSOLE / INCS-SL

NAVY  NAVY PRT APPROVED

LifeFitness

LifeFitness

ASPIRE CARDIO

A streamlined and efficient cardio line that includes a treadmill, elliptical, upright bike and recumbent bike. Aspire Cardio provides effective workouts, and memorable exerciser experiences, for a wide range of users. Aspire has an inviting modern design and is built with the advanced biomechanics and focus on durability that Life Fitness cardio is known for.



**TREADMILL WITH SL CONSOLE
/ ASPT-SL**

Other options:

- Treadmill with SE4 Console (24") / ASPT-SE424
- Treadmill with SE4 Console (16") / ASPT-SE416



**ELLIPTICAL CROSS-TRAINER
WITH SL CONSOLE / ASPX-SL**

Other options:

- Elliptical with SE4 Console (16") / ASPX-SE416



**UPRIGHT LIFECYCLE EXERCISE BIKE
WITH SL CONSOLE / ASPC-SL**

Other options:

- Upright with SE4 Console (16") / ASPC-SE416



**RECUMBENT LIFECYCLE EXERCISE
BIKE WITH SL CONSOLE / ASPR-SL**

Other options:

- Recumbent with SE4 Console (16") / ASPR-SE416

ASPIRE CARDIO CONSOLE

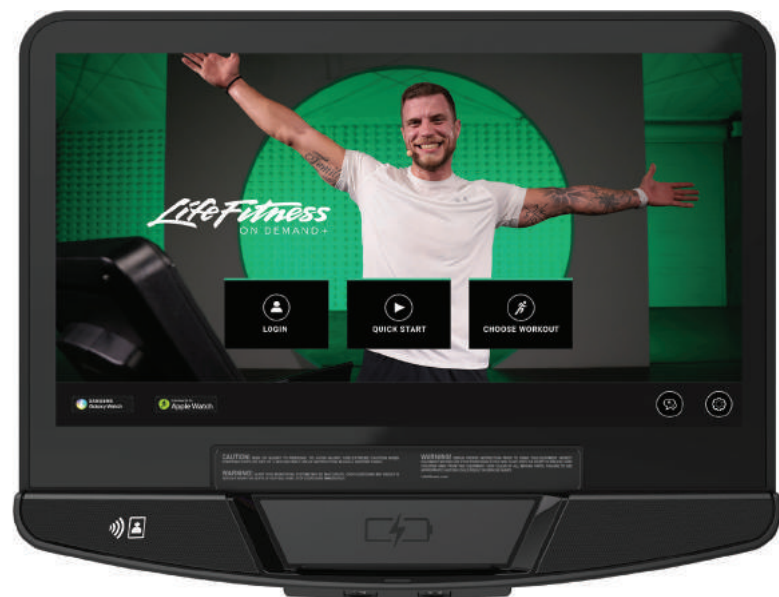

DISCOVER SE4 CONSOLE

The state-of-the-art console has a 16" screen (24" also available on Aspire treadmill) for an immersive experience and access to hundreds of workouts through Life Fitness™ On Demand+.

The visually rich 1080p touch screen employs cutting-edge AIT technology for an incredibly responsive user interface. Exercisers can seamlessly sync a smartphone, tablet or other device using Bluetooth® or NFC technology and the console offers convenient wireless phone charging.



SL CONSOLE

Rethink LED. Bluetooth®, ANT+ and NFC provide connection to wearables, headphones, heart rate straps and more. Pairs wirelessly with Apple Watch®. Up to 22 workouts available.



ASPIRE CARDIO

Cardio equipment options that appeal to exercisers of all abilities and fitness goals.

TREADMILLS

A streamlined all-purpose treadmill that features a large accessory tray and cross handrail that allows for plenty of running room.

CROSS-TRAINERS

An elliptical path that feels extremely natural because the path of motion is similar to an exerciser's actual running stride.

UPRIGHT BIKES

Rooted in decades of proven durability. The generator drive system with poly-V belt resistance requires limited maintenance and also offers a smooth, quiet operation.

RECUMBENT BIKES

A backrest, lumbar support and a wrap-around adjustment lever combine to help exercisers achieve maximum comfort.



WHY LIFE FITNESS CARDIO



ACTIVATE SERIES

Light commercial cardio that combines reliability with intuitive functionality.

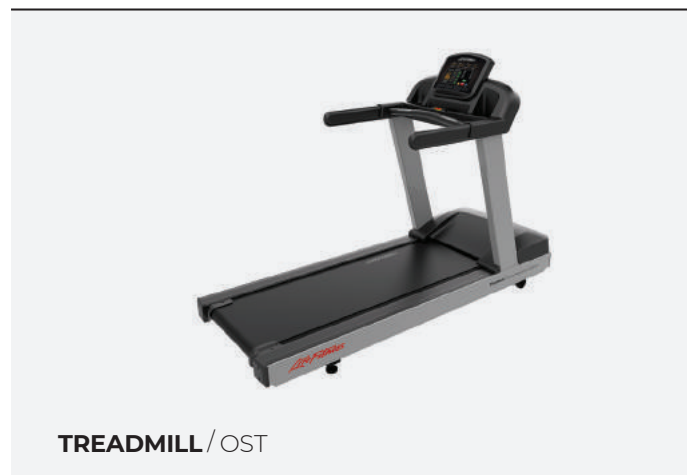

TREADMILL / OST

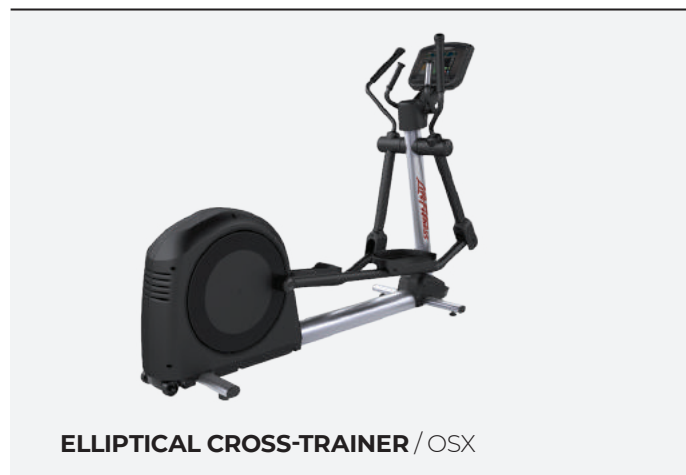

ELLIPTICAL CROSS-TRAINER / OSX

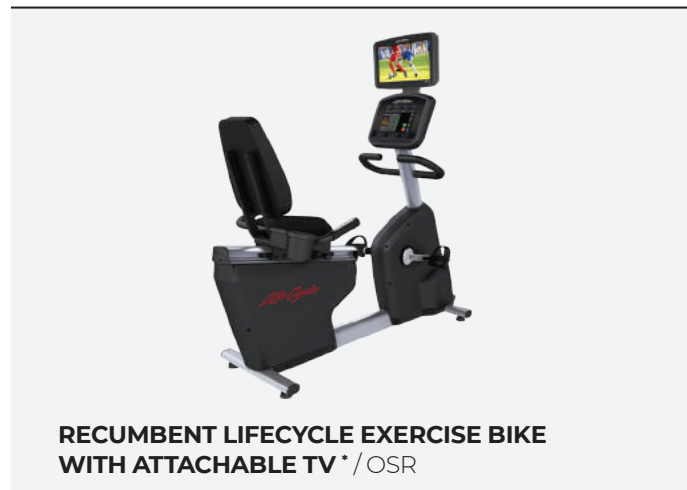

RECUMBENT LIFECYCLE EXERCISE BIKE WITH ATTACHABLE TV* / OSR



UPRIGHT LIFECYCLE EXERCISE BIKE / OSC



DESIGN

Aesthetic design doesn't stand on its own. It requires a framework of functionality. Every detail is considered in order to design cardio equipment that provides the best results for its exercisers.



DURABILITY

Extensive testing in the \$4 million reliability lab at Life Fitness ensures our cardio products meet the highest global standards and are built to last in any environment.



CONSTRUCTION

Building the best fitness equipment in the industry has always been our goal at Life Fitness. We maintain ISO 9001 certification and manufacture equipment under the highest quality standards.



GROUP TRAINING

A variety of high-intensity interval training options provide an effective cardio component to any group training program. Each product is also ideal for use during individual cardio workout.



HEAT ROW



CONSOLE DISPLAYS:
Time, Distance, Strokes/Minute, 500-Meter Split Time, Calories/Hour, Watts

HEAT ROW / PRF-ROW-LCD-01

The intuitive LCD console offers an easy-to-use digital experience with accurate feedback.

HEAT PERFORMANCE ROW / PRF-ROW-TFT-01

The TFT2.0 console offers high-tech digital feedback and motivational programs to enhance the rowing experience.

SPARC



HD SPARC / PT-SC

CONSOLE DISPLAYS:
Brake Resistance Level Meter, Numeric Display of Meters/km, Seconds, Strides per Minute, Time, Total Time, Watts

ICG INDOOR CYCLES

Indoor Cycling Group (ICG) has been motivating, mentoring, and measuring positive change in the lives and rides of the global fitness and sporting community since 1995.

Striving for excellence in indoor cycling has made ICG a global leader specializing in the design, manufacture and programming of premium indoor cycling equipment.



ATTENTION TO COMFORT

A padded sport saddle, PVC multi-position handlebars and multiple adjustment possibilities ensure that riders are comfortable from the start of the workout to the end.



WATTRATE® TFT

The WattRate® TFT Computer 2.0 has a bright, self-powered, fully integrated TFT screen and a front LED display, which simultaneously display one of five colored zones to match the user's WattRate® (power) reading or heart rate output.



ADVANCED POWER METRICS

The WattRate® Direct Power Meter on IC7 bikes offers the market's most accurate sensor technology with a direct measuring tolerance of +/- 1%.

OPTIMAL Q FACTOR

Q Factor is the distance between an exerciser's feet when they sit on a bike and pedal. The industry standard Q Factor of 155mm on most ICG bikes results in a ride that feels comfortable and natural.

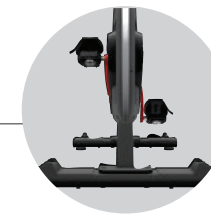

POLY-V BELT DRIVE

The Poly-V belt drive that powers each ICG bike transfers extreme levels of torque smoothly, requires limited maintenance, and is quieter than other drive systems.



INVITING DESIGN

A sleek and modern aesthetic combines with rugged features like a steel frame to create durable cycles that exercisers want to use.



STATE-OF-THE-ART INDOOR CYCLES

This fleet of bikes combines striking, award-winning design with an enhanced digital experience.



IC7 / IC-LFICGIC7-01

- Two-stage drivetrain and a premium digital experience
- Includes a WattRate Direct Power Meter, Coach By Color® intensity guide for user and instructor, and data exchange with devices
- A new, sleek design with black anodized components



IC6 / IC-LFICGIC6-01

- WattRate TFT computer features performance indication in watts, data exchange with external devices
- Coach By Color® intensity guide for both the user and instructor



IC5 / IC-LFICGIC5-01

- WattRate LCD computer displays performance and allows for data exchange with devices and the Coach By Color® intensity guide for users



The state-of-the-art engineering of ICG indoor cycles combines with engaging digital technology to create extremely memorable exerciser experiences.

COACH BY COLOR



VERY LIGHT LIGHT MODERATE VERY HARD MAXIMUM

Color-coded biofeedback for exercisers, and a universal method for coaching intensity for instructors.



ICG CONNECT

A digital platform that creates exciting and immersive group exercise experiences through competition, vivid data visualization and instructor encouragement.

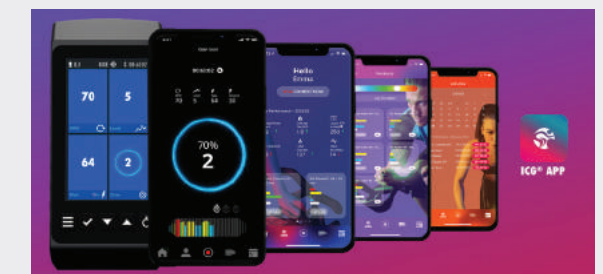

ICG TRAINING APP

The Apple® and Android™ app pairs with IC5, IC6, and IC7 bikes to give exercisers the power to view, save and track workouts.



SYNRGY180

The SYNRGY180 functional group training system helps save space by doubling as a wall-adjacent unit. It can be custom-configured to have a core unit, with another add-on, and side units for storage space, suspension, HIIT elements and added variety.

PRECONFIGURED PACKAGES



MIX 3

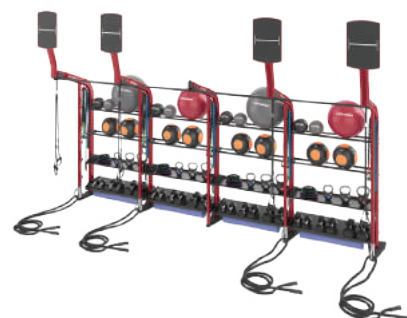

MULTI 4



DUO 4

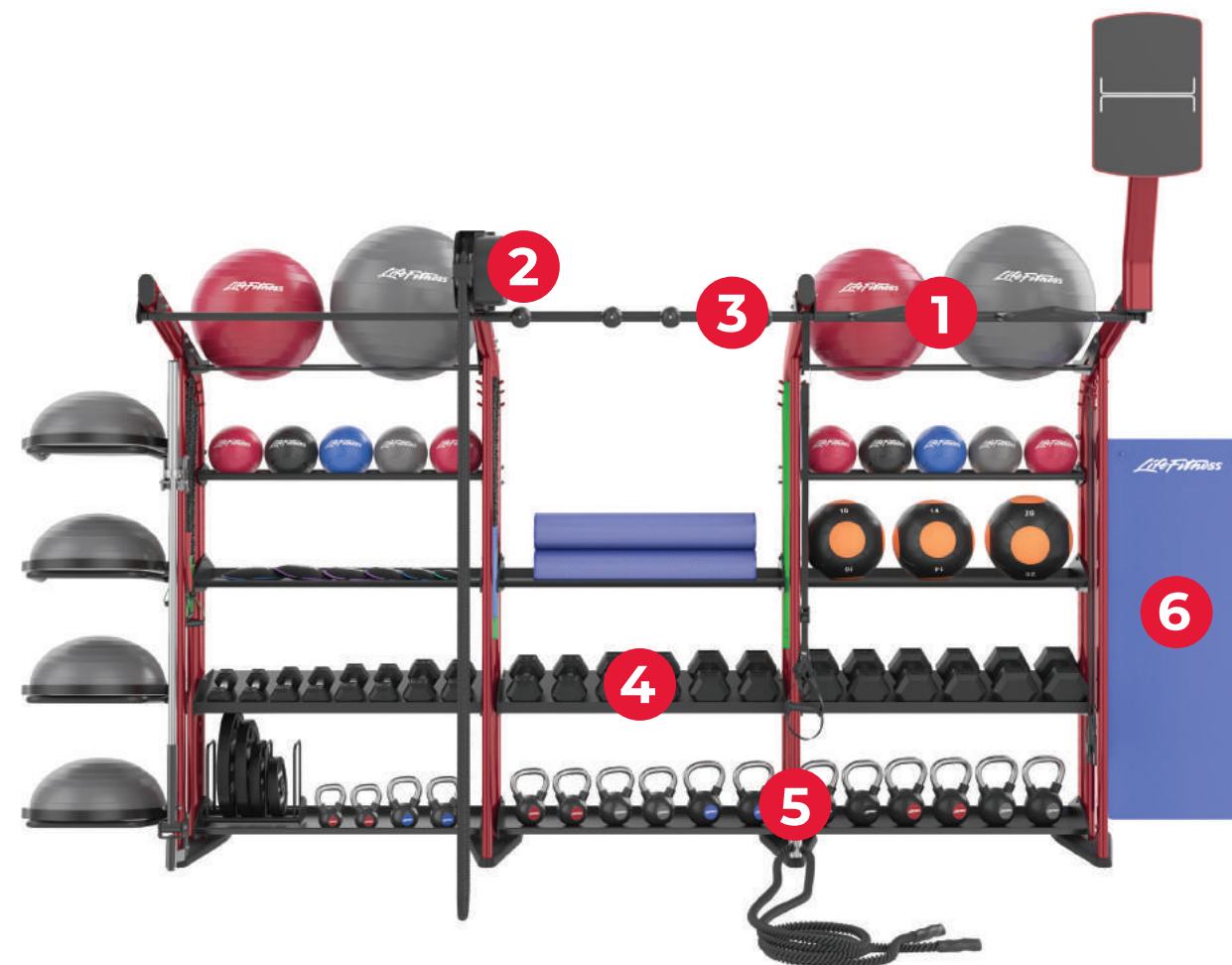

- 1 STABILITY BALL STORAGE OPTION
- 2 TOP FRAME OPTIONS
- 3 CHIN OPTIONS
- 4 SHELF OPTIONS
- 5 BOTTOM FRAME OPTIONS
- 6 SIDE STORAGE OPTIONS

FREESTANDING SYSTEM

Add Stabilization Legs and a rear Counterbalance to allow SYNRGY180 to be freestanding and not bolt-to-floor.





SYNRGY360

The groundbreaking SYNRGY360™ system reinvents small group training. It creates a fun, inviting and meaningful workout experience for exercisers of all abilities and fitness levels.

SYNRGY360 units are available in several sizes and different customizable configurations.

The energy created around a SYNRGY360 system makes it the exciting focal point of any facility.



SYNRGY90

A nearly limitless variety of exercise options in one space. Rooted in the success of SYNRGY360 small group training, the SYNRGY90 system is a shift in contemporary personal training—it provides the structural space trainers need, offers nearly limitless configurability and fits seamlessly in dedicated spaces.



CABLE CABLE /SYN90-CC



CABLE VERSA /SYN90-CV



VERSA CABLE /SYN90-VC



VERSA VERSA /SYN90-VV

SYNRGY360 T



Contribute to exercisers' success with the variety afforded by five available training spaces in this streamlined configuration.*

2
PLACES TO TRAIN

MAX. FOOTPRINT:
5.8' x 7.6' (1.75 m x 2.31 m)
LIVE AREA:
11' x 22' (3.4 m x 6.7 m)



SYNRGY360 XS

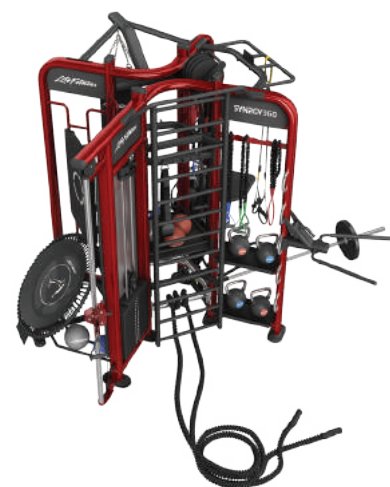

This space-efficient training hub consolidates the variety of four distinctive training spaces with ample accessory storage.*

4
PLACES TO TRAIN

MAX. FOOTPRINT:
7.7' x 9.0' (2.34 m x 2.74 m)
LIVE AREA:
22' x 22' (6.7 m x 6.7 m)

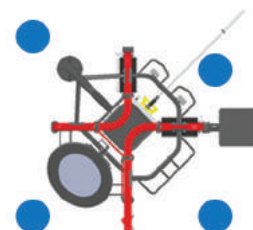

SYNRGY360 XM



Make a bold statement about your facility's commitment to fitness with six available training spaces including a seven-handle monkey bar zone.*

6
PLACES TO TRAIN

MAX. FOOTPRINT:
9.0' x 14.4' (2.74 m x 4.39 m)
LIVE AREA:
22' x 27' (6.7 m x 8.2 m)

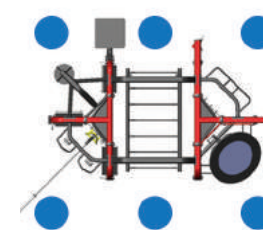

SYNRGY360 XL

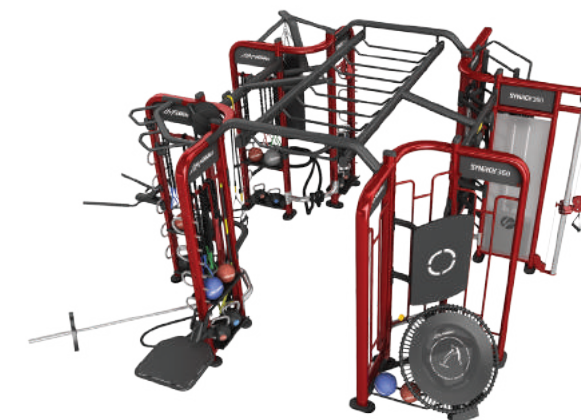

Our premier training destination has eight unique training spaces, including a 10-handle monkey bar zone and two dedicated areas for suspension training.*

8
PLACES TO TRAIN

MAX. FOOTPRINT:
14.4' x 14.4' (4.39 m x 4.39 m)
LIVE AREA:
27' x 27' (8.2 m x 8.2 m)

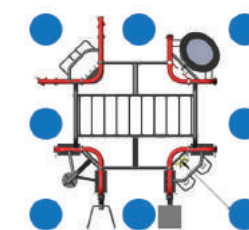

OPTIONAL CABLE CROSSOVER CONNECTOR

Combine SYNRGY360 units by connecting cable stations with the optional cable crossover connector to create a different training environment and added interior space.*

- Supports multiple suspension trainers
- Additional chin handles
- Available in three lengths: 6' (1.82 m), 7' (2.13 m), 8' (2.44 m)

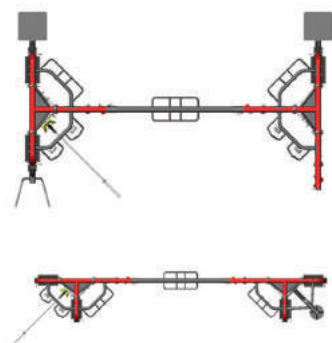
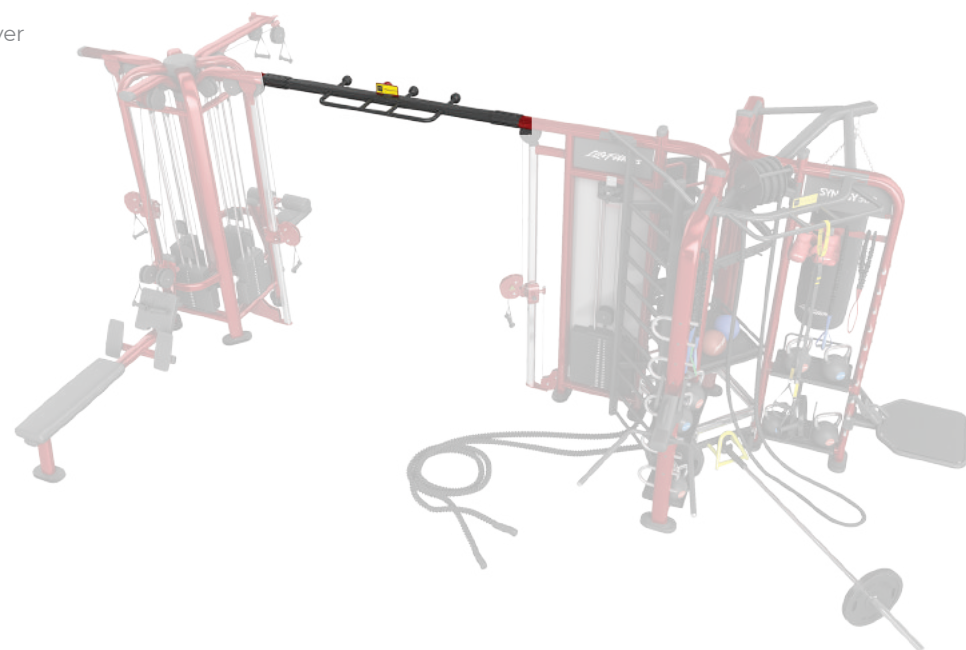

- 1** REBOUNDER
- 2** CABLE MOTION
- 3** ROPE PULL
- 4** BATTLE ROPE
- 5** PULL-UP BARS / TRX ANCHOR
- 6** STORAGE FOR ACCESSORIES
- 7** PLATFORM/DIP

*CONTACT YOUR SALES REPRESENTATIVE FOR PRICING AND ADDITIONAL CONFIGURATIONS.

*SYNRGY360 UNITS MUST BE SECURED TO A CONCRETE FLOOR FOR STABILIZATION AND TO ELIMINATE ROCKING OR TIPPING.

LIFE FITNESS STRENGTH

INSIGNIA SERIES
THOUGHTFULLY DESIGNED.
DISTINCTIVELY CRAFTED.

Subtle design elements and detailed attention to the exerciser experience create intuitive strength training equipment that operates with smooth and controlled motions.

Insignia™ Series is the optimal interaction between exerciser and machine.

INSIGNIA SERIES

INSIGNIA



SHOULDER PRESS / SS-SP



CHEST PRESS / SS-CP



CHEST PRESS (DUAL AXIS) / SS-CPX



ROW / SS-RW



PULLDOWN / SS-PD



PULLDOWN (DUAL-AXIS) / SS-PDX



BICEPS CURL / SS-BC



BICEPS CURL DEPENDENT / SS-BCD



LATERAL RAISE / SS-LR



TRICEPS PRESS / SS-TP



TRICEPS EXTENSION / SS-TE



GLUTE / SS-GL



ASSIST DIP CHIN / SS-ADC



PECTORAL FLY/REAR DELT / SS-FLY



GLUTE BRIDGE / SS-GLD



LEG EXTENSION / SS-LE



SEATED LEG CURL / SS-SLC



ARC LEG PRESS / SS-SLP



LEG CURL / SS-LC



CALF EXTENSION / SS-CE



HIP ABDUCTION / SS-HAB



HIP ADDUCTION / SS-HAD



HIP ABDUCTION/ADDUCTION / SS-HAA



ABDOMINAL / SS-AB



ABDOMINAL ADVANCED / SS-ABD



BACK EXTENSION / SS-BE



TORSO ROTATION / SS-TR



PREMIUM STRENGTH PROGRESSION

Plate-Loaded units provide independent, converging and diverging movements.

Cable Motion™ Technology challenges exercisers with user-defined paths of motion that help build balance and power.



SIGNATURE SERIES



BICEPS CURL / SPLBC



DECLINE CHEST PRESS / SPLDCP



FRONT LAT PULLDOWN / SPLPD



HIGH ROW / SPLHR



INCLINE CHEST PRESS / SPLIP



ROW / SPLROW



SEATED DIP / SPLDIP



SHOULDER PRESS / SPLSP

SIGNATURE SERIES: PLATE-LOADED



LINEAR LEG PRESS / SPLLLP



KNEELING LEG CURL / SPLKLC



LEG EXTENSION / SPLLE



CALF RAISE / SPLCALF

TWO-TONE FRAME AND WORKARM FEATURE

* Workarms available in textured Shadow Gray and other Signature Series standard/premium color options. Shadow Gray only available on workarms. See color chart for all available color options.

Only available on Signature Plate-Loaded.



COLOR OPTION: TEXTURED SHADOW GRAY*

CUSTOM COLOR: CANDY APPLE RED



SIGNATURE SERIES: CABLE MOTION



DUAL ADJUSTABLE PULLEY / CMDAP

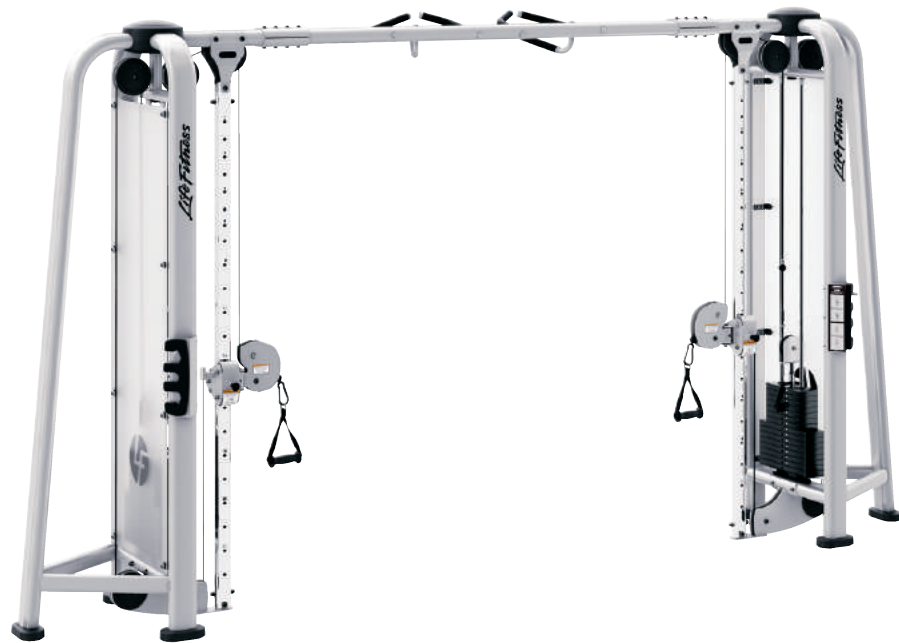

ADJUSTABLE CABLE CROSSOVER / CMACO

SIGNATURE SERIES: MULTI JUNGLE



MULTI-JUNGLE DUAL PULLEY HIGH / MJDPH



MULTI-JUNGLE ASSISTED CHIN DIP LOW / MJADC



MULTI-JUNGLE DUAL PULLEY LOW / MJDPL



MULTI-JUNGLE PLATFORM (SAMPLE 4-STACK) / MJ4*



MULTI-JUNGLE PLATFORM (SAMPLE 5-STACK) / MJ5*



MULTI-JUNGLE PLATFORM (SAMPLE 8-STACK) / MJ8*



MULTI-JUNGLE PLATFORM (SAMPLE 12-STACK) / MJ12S*



MULTI-JUNGLE PLATFORM (SAMPLE (12-STACK V-SHAPE) / MJ12V*

*CONTACT YOUR SALES REPRESENTATIVE FOR CUSTOM CONFIGURATIONS.

BENCHES AND RACKS



OLYMPIC FLAT BENCH / LBR-OF



OLYMPIC INCLINE BENCH / LBR-OI



OLYMPIC DECLINE BENCH / SLBR-OD



OLYMPIC MILITARY BENCH / LBR-OM



OLYMPIC BENCH WEIGHT STORAGE / LBR-OW



OLYMPIC SQUAT RACK / LBR-OW



ARM CURL BENCH / LBR-BC



BACK EXTENSION / SBE



FLEXIBILITY TRAINER / LBR-FS



FLAT BENCH / LBR-FB



ABDOMINAL CRUNCH BENCH / LBR-AC



UTILITY BENCH / LBR-UB



CHIN/DIP/LEG RAISE / LBR-LC



DIP/LEG RAISE / LBR-LD



ABDOMINAL BENCH / LBR-AB



ADJUSTABLE BENCH / LBR-AD



ADJUSTABLE DECLINE BENCH / LBR-DB



MULTI-ADJUSTABLE BENCH / LBR-MA

STORAGE



TWO-TIER DUMBBELL RACK / LBR-D2



BARBELL RACK / LBR-BR



OLYMPIC WEIGHT TREE / LBR-OT



3-TIER ACCESSORY RACK / OP-AR3



3-TIER DUMBBELL RACK / LBR-DF



3-TIER SHORT SADDLE DUMBBELL RACK / LBR-DS



3-TIER LONG SADDLE DUMBBELL RACK / LBR-DL



BARBELL RACK / LBR-BB



VERTICAL DUMBBELL RACK / LBR-DV



VERTICAL MEDICINE BALL STORAGE / LBR-MB



MODULAR ACCESSORY STORAGE SYSTEM / SMSS

**ATTRACTIVE.
EFFICIENT.
RELIABLE.**

Axiom Series is a comprehensive line of strength equipment that includes single and dual-exercise selectorized units, a dual adjustable pulley, and benches and racks. Inviting design and inviting exerciser functionality combine to create a strength line ideal for any facility.



AXIOM SERIES



**DUAL ADJUSTABLE
PULLEY / OP-DAP**

- 90" (228 cm) of cable accommodates full body movements
- Ergonomic pull-up bar with neutral, chin-up, and pull-up grip positions
- Optimized weight stack position minimizes product width without sacrificing function
- Included: Long adjustable handles, pair (x1), Ankle strap (x1), Triceps rope (x1)

AXIOM SERIES: SINGLE-EXERCISE MACHINES



CHEST PRESS /
OP-CP



SEATED ROW /
OP-RW



SHOULDER PRESS
/ OP-SP



LAT PULLDOWN /
OP-PD



LEG PRESS /
OP-LP



BICEPS CURL /
OP-BC



TRICEPS EXTENSION /
OP-TE



LEG EXTENSION /
OP-LE



LEG CURL / OP-LC



ABDOMINAL /
OP-AB

AXIOM SERIES: DUAL-EXERCISE MACHINES



MULTI-PRESS / OP-MP



PULLDOWN/ROW / OP-LR



PECTORAL FLY/REAR
DELTOID / OP-FLY



BICEPS CURL/TRICEPS
EXTENSION / OP-BT



HIP ABDUCTION/
ADDUCTION / OP-HAA



LEG CURL/EXTENSION
/ OP-LCE



SEATED LEG CURL/
EXTENSION / OP-SLCE



ABDOMINAL/BACK
EXTENSION / OP-ABBA



STUDIO COLLECTION

ACCESSORIES



Studio Collection accessories are designed following color theories and common user preferences. The simple, organizational benefits and accessibility make the Studio Collection perfect for exercisers and club owners alike. These accessories—along with our other products—are the finishing touch for a complete facility, saving time and effort for customers.

FEATURES:

- Each rack is the same height and each type of weight utilizes the same color strategy. This gives your studio a collection of products that fit and work together as a family.
- Organizational efficiency allows this collection to fit in any space.
- Colors and design aesthetics make group studio classes more inviting.



DUMBBELL PACK / LF-GDBLB



KETTLEBELL PACK* / LF-STKBR



BARBELL PACK / LF-GBBLB



STEP / LF-STP-1001



RISER / LF-STP-1002



DECK / LF-DK-1000



STEP & RISER SET / LF-STP-1000

* Kettlebells sold separately.



HAMMER



HD PERFORMANCE TRAINERS

The Hammer Strength HD Tread, HD Air Bike and HD SPARC allow service members to get on and go with no hassle and maximum results. Within seconds, you can have your members pushing the limits of their HIIT workouts. Added to an existing training program, these products complete a well-rounded dynamic.



HD TREAD

PT-ST-01

A durable, self-powered curved treadmill made for performance training. Quick, efficient and tough enough to match the standards and expectations of the roughest exercisers.



HD AIR BIKE

PT-AB-01

An anaerobic endurance machine that allows your service members to quickly raise—or maintain—their heart rate. It is also excellent for injury prevention and recovery because there's no impact on an exerciser's joints.



HD SPARC

PT-SC-01

The ultimate performance trainer for explosiveness and power. It utilizes a high knee position and engages the glutes and muscles used to create downward-driving force. This translates to acceleration, speed and explosiveness training efficiency.

HAMMER STRENGTH SELECT

Built with the Hammer Strength philosophy of performance strength training, Hammer Strength Select combines attention to effective movement with a rugged industrial aesthetic.



SEATED ROW / HS-RW



SHOULDER PRESS / HS-SP



TRICEPS EXTENSION / HS-TE



HIP ABDUCTION / HS-HAB



HIP ADDUCTION / HS-HAD



HIP AND GLUTE / HS-HG



HORIZONTAL CALF / HS-HC



LEG CURL / HS-LC



ASSIST DIP CHIN / HS-ADC



BICEPS CURL / HS-BC



CHEST PRESS / HS-CP



FIXED PULLDOWN / HS-FPD



LEG EXTENSION / HS-LE



SEATED LEG CURL / HS-SLC



SEATED LEG PRESS / HS-SLP



STANDING CALF / HS-SC



LAT PULLDOWN / HS-PD



LATERAL RAISE / HS-LR



PECTORAL FLY / HS-PEC



PEC FLY/REAR DELT / HS-FLY



ABDOMINAL CRUNCH / HS-ABC



BACK EXTENSION / HS-BE

MTS

MOTION. TECHNOLOGY. SELECTORIZED.

Hammer Strength extends the same Motion Technology of its revolutionary plate-loaded machines to its Motion Technology Selectorized™ (MTS) equipment. Only Hammer Strength MTS incorporates patented Iso-Lateral® technology with the ease and convenience of selectorized weight stacks.



MOTION. TECHNOLOGY. SELECTORIZED.



ABDOMINAL CRUNCH / MTSAB



ISO-LATERAL BICEPS CURL / MTSBC



ISO-LATERAL CHEST PRESS / MTSCP



ISO-LATERAL INCLINE PRESS / MTSIP



ISO-LATERAL ROW / MTRW



ISO-LATERAL SHOULDER PRESS / MTSSP



ISO-LATERAL DECLINE PRESS / MTSDP



ISO-LATERAL FRONT PULLDOWN / MTSFP



ISO-LATERAL HIGH ROW / MTSHR



ISO-LATERAL TRICEPS EXTENSION / MTSTE



ISO-LATERAL LEG EXTENSION / MTSLE



ISO-LATERAL KNEELING LEG CURL / MTSKC

PLATE-LOADED

BUILDING CHAMPIONS

Hammer Strength is the No. 1 brand of plate-loaded equipment in the world and offers some of the industry's most advanced strength-training technologies.

With the pioneering vision and guidance of founder Gary Jones, Hammer Strength became the first to explore the ergonomic advantages of utilizing converging and diverging arcs of motion. With more than 50 plate-loaded products—including the revolutionary Ground Base® machines—Hammer Strength gives you the power to build champions at any level.



BELT SQUAT / PL-BSQ



GLUTE HAM / REVERSE HYPER / BW-GHRH



GLUTE DRIVE / PL-GLD



ISO-LATERAL INCLINE PRESS / IL-IP



ISO-LATERAL LOW ROW / IL-LR



ISO-LATERAL ROW / IL-ROW



ISO-LATERAL SHOULDER PRESS / IL-SP



ISO-LATERAL BENCH PRESS / IL-BP



ISO-LATERAL CHEST/BACK / IL-CB



ISO-LATERAL D.Y. ROW / IL-DRW



ISO-LATERAL DECLINE PRESS / IL-DCP



ISO-LATERAL SUPER INCLINE PRESS / IL-FMP



ISO-LATERAL WIDE CHEST / IL-WC



ISO-LATERAL WIDE PULLDOWN / IL-WPD



4-WAY NECK / PL-4W



ISO-LATERAL FRONT LAT PULLDOWN / IL-PD



ISO-LATERAL HIGH ROW / IL-HR



ISO-LATERAL HORIZONTAL BENCH PRESS / IL-HBP



T-BAR ROW / PL-TBR



SEATED DIP / PL-DIP



LATERAL RAISE / PL-LR



PULLOVER / PL-PO



SEATED BICEPS / PL-BI

PLATE-LOADED



ISO-LATERAL KNEELING LEG CURL / IL-KLC



ISO-LATERAL LEG CURL / IL-LC



ISO-LATERAL LEG EXTENSION / IL-LE



ISO-LATERAL LEG PRESS / IL-LP



LEG EXTENSION / PL-LE



LEG PRESS / PL-LP



LINEAR HACK SQUAT / PL-LHS-01



LINEAR LEG PRESS / HSLLP



SEATED CALF RAISE / PL-CALF



SEATED LEG CURL / PL-SLC



SUPER HORIZONTAL CALF / PL-SHC



TIBIA DORSI FLEXION / PL-TIB



V-SQUAT / PL-VSQ



GRIPPER / PL-GRIP



SEATED/STANDING SHRUG / PL-SH



ABDOMINAL OBLIQUE CRUNCH / PL-AB

GROUND BASE

UNMATCHED PERFORMANCE TRAINING

Hammer Strength Ground Base® machines provide advanced performance training with unique technology. The challenging multi-plane exercises build strength, balance, and coordination that directly transfer to real-world actions and moves on the playing field. By training with feet on the ground, users can perform explosive movements to maximize their power and endurance by engaging multiple muscle groups including the core.



GROUND BASE



COMBO DECLINE / GB-CD



COMBO INCLINE / GB-CI



COMBO TWIST / GB-CT



JAMMER / GB-J



SQUAT HIGH PULL / GB-SHP



SQUAT LUNGE / GB-SL



TWIST LEFT / GB-TL



TWIST RIGHT / GB-TR



HD ELITE **iD**

A RACK SYSTEM WITHOUT LIMITATIONS.

Hammer Strength's most premium racks are crafted with elite athletes and world-class facilities in mind. The amazing configurability of HD Elite iD lets you create unparalleled training experiences that evolve with you.



HD ELITE 10 RACKS

BUILDING CHAMPIONS

This customizable and highly modular rack system was created for those who want to push the limit of what a rack can do. With unrivaled rigidity, impeccable functionality and meticulous design, these racks are engineered to thrive in the most demanding athletic environments and high-performance facilities.



PERFORMANCE FEATURES



ANVIL BRACING™

Multi-plane bolting configuration increases structural rigidity.



HAMMERLOCK™

Bolting mechanism allows for higher fastening torque and eliminates exposed hardware for a cleaner look.



CO-BRANDING*

Show your team or facility pride by adding your custom logo.

*Co-branding is only available in North American markets.



7-GAUGE STEEL

50% thicker walls than 11 gauge ensures that your rack has the mass to feel rigid and holes won't deform over time.

BUILD THE RACK THAT BEST FITS YOUR WEIGHT ROOM FROM THESE STANDARD RACK BASE TYPES.



STANDARD HALF RACK / ELT-HR-STRD



STANDARD POWER RACK / ELT-PR-STRD



COMBO RACK

CABLE STATIONS

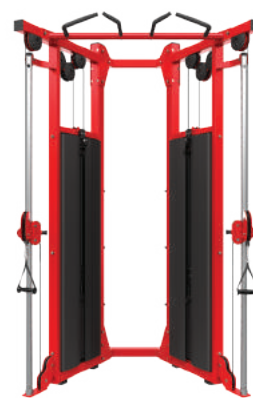

HD ELITE DUAL ADJUSTABLE PULLEY / HDLAP



HD ELITE PULLDOWN / HDLPD



HD ELITE DUAL PULLDOWN ROW / HDL DPR



HD ELITE ROW / HDLRW



HD ATHLETIC

EASILY CREATE YOUR OWN PERFORMANCE TRAINING SPACE

HD ATHLETIC NX

HD Athletic NX is the next generation of HD Athletic Racks. It's highly configurable, easily upgradable and offers a wide range of strength training options. There's no limit to how athletes can train with HD Athletic NX.

HD ATHLETIC PRO

HD Athletic Pro creates massive training flexibility out of small spaces. HD Athletic Pro is for the customer that needs integrated barbell solutions with practical accessory storage and functional training. Configure the structures that best fit your room by maximizing open floorspace without limiting the number of bars moving.

ATHLETIC NX

RACK

NX is a modular line of Racks that can be right sized to fit your space and your budget. At Hammer Strength, we don't compromise on performance. NX is ideal for high schools and training facilities that deserve Hammer Strength level quality and desire choices to create the perfect fit.



HD ATHLETIC NX SERIES RACKS



POWER RACK



HALF RACK



COMBO RACK



SQUAT STAND





HD ATHLETIC PRO

PERFORMANCE STRENGTH TRAINING THAT MAXIMIZES SPACE

HD ATHLETIC BRIDGE

Olympic training and storage options are connected by an overhead bridge that offers the opportunity for group strength training, body weight training and more. Open space underneath the Bridge can also be used for a variety of general group exercise. Several configuration sizes fit nearly any space.

HD ATHLETIC PERIMETER

A depth of 32" ensures that Perimeter fits unobtrusively against a wall. Connect several together to create a performance strength training wall or large storage area.

BRIDGE CONFIGURATIONS*

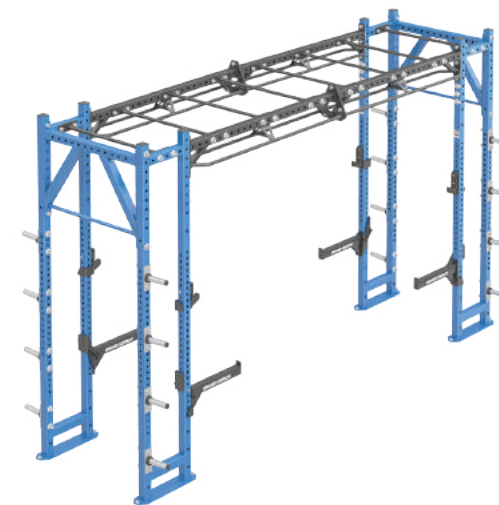

SINGLE

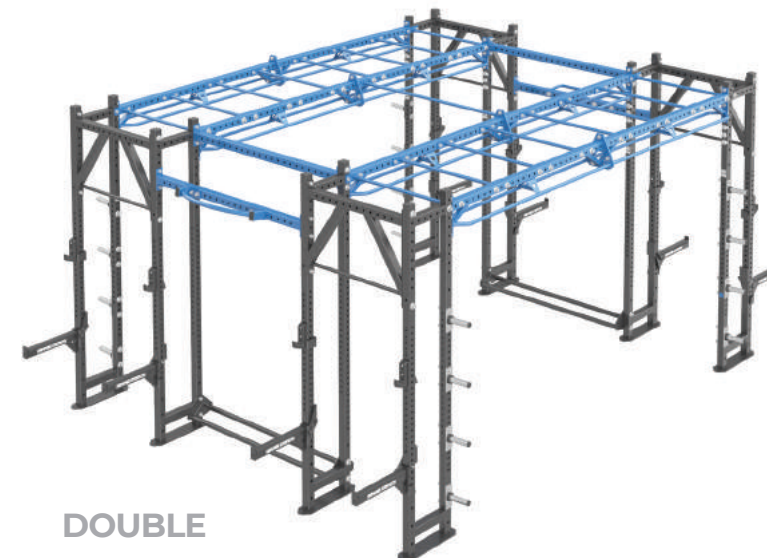

DOUBLE

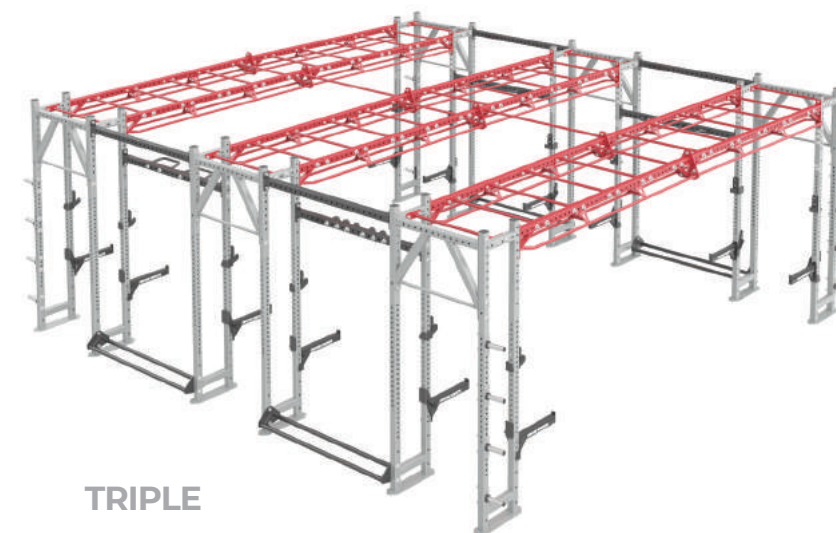

TRIPLE

PERIMETER CONFIGURATIONS*



14' PERIMETER UNIT



4' PERIMETER UNIT



STORAGE-ONLY PERIMETER

Call for pricing and additional configurations. Images not to scale. Products subject to change.

*All rig configurations require bolt to floor.



UNIVERSAL ADD-ONS

Build the training system that challenges anyone with nearly limitless configuration options.

Choose from a wide range of add-ons, cross-members and storage possibilities. Nearly all are compatible with HD Elite iD, HD Athletic NX, Perimeter and Bridge.



Scan to learn more about add-on options.

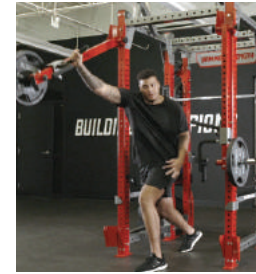

LIGHTNING ARMS



NORDIC HAM

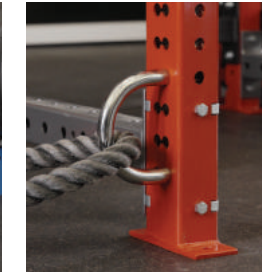

BATTLE ROPE ATT.



UTILITY BAND PEG

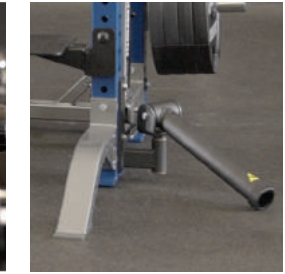

POWER PIVOT



MOD. POWER PIVOT



LOCK KNOB



UTILITY PAD



TOP BALL STORAGE



WALL BALL TARGET



HEAVY BAG HANGER



DIP HANDLE



DOCK 'N' LOCK

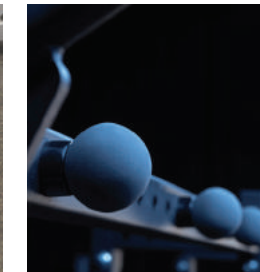

3" BALL GRIP



ARC BAR

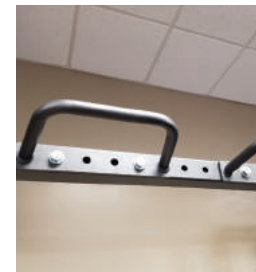

NEUTRAL GRIPS



SPOTTER PLATFORMS



CUSTOM SIGNS



CUSTOM ANVIL PLATES



SQUARE RACK CONNECTORS



3 X 3 SQUARE



PERCH XM



WING



BALLISTIC WING



SPIDER GUSSET

Note: Not all options are listed. Contact your sales representative for more information.



UNIVERSAL ADD-ONS

BAR AND WEIGHT STORAGE

Ensure that the tools of the trade are easy to access. Smart storage options result in more efficient workouts.



STANDARD WEIGHT HORN



XL WEIGHT HORN

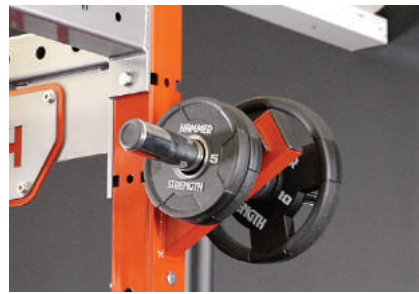

BULL HORN



2-BAR HANGER

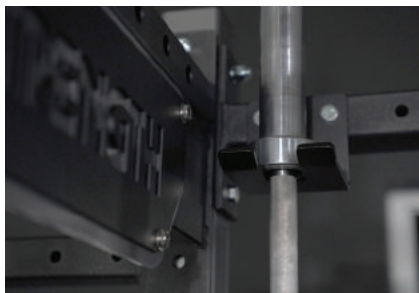

SINGLE BAR HANGER

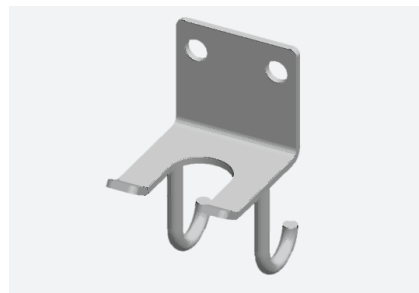

THICK BAR HANGER



SPECIALTY BAR STORAGE



LOW BAR STORAGE



PRO BAR STORAGE



UTILITY STORAGE POST



STORAGE TRAYS



MODULAR ACCESSORY STORAGE

BAR SUPPORTS AND CATCHES



ID BAR SUPPORTS

A 3/8"-thick bent plate with 3/8"-thick paint guards to protect the rack and dampen sound. Using molded urethane covers, the supports have a 5-1/2" landing zone, providing a large target and a 1-1/2" resting surface to ensure the bar is always balanced. A zinc-plated rod allows for smooth height adjustments.



ID HALF RACK BAR CATCHES

22" (56 cm) long with a 3-sided urethane guard to shield the catch and the bar. Two shock absorption pads and vertical displacement brackets prevent rack damage. Bar catch pins through the side of the rack for added stability.



FLEXIBLE BAR CATCHES

Help ensure a safe training zone when inside a power rack. Reinforced nylon straps disperse impact to the rack and prevent knurling damage to bars. The front and back of the straps can be offset so the bar rolls away if dropped when squatting.



PREMIUM POWER RACK BAR CATCHES

For HD Athletic NX Power Racks and designed with 2" x 3", 11-gauge tubing with a 1/2" solid steel rod from upright to upright. High-wear charcoal finish with a 3-sided urethane guard protects the bar and catch. All contact areas are protected with 3/8" urethane guards. Catches lock into place using Utility Band Pegs.



STANDARD HALF RACK BAR CATCHES*

18" (46 cm) long with a 3-sided urethane guard to shield the catch and the bar. The catch pins from the face of the rack and locks in place. Charcoal finish is a durable matte powder coating that includes paint guard tape to protect the uprights.



PREMIUM HALF RACK BAR CATCHES*

22" (56 cm) long with a 3-sided urethane guard to shield the catch and the bar. Shock absorption pads and vertical displacement brackets prevent rack damage. The catch pins through the side of the rack for added strength. High-wear charcoal powder-coated finish with a chrome pin.



STANDARD BAR SUPPORTS*

A welded 3/8" plate protected by an injection-molded urethane cover for bar protection. Charcoal finish is a matte powder coating that includes paint guard tape to protect the uprights.



PREMIUM BAR SUPPORTS*

A welded 1/2" plate protected by an oversized, injection-molded urethane cover for bar protection. Landing area is 2" that tapers to 1.3" for wide hand clearance. High-wear charcoal powder-coated finish with a chrome pin. The interior is wrapped with 3/8" urethane paint guards to prevent metal-on-metal contact.

*Compatible with HD Athletic NX Racks only.

Note: Not all options are listed. Contact your sales representative for more information.

BENCHES AND RACKS

Hammer Strength benches and racks anchor complete strength-training destinations. These tough-built essentials support good fundamentals for targeted training.



BENCHES AND RACKS

BENCHES AND RACKS



OLYMPIC FLAT BENCH / O-FB



OLYMPIC INCLINE BENCH / O-IB



OLYMPIC DECLINE BENCH / O-DB



OLYMPIC BENCH WEIGHT STORAGE / O-BWS



OLYMPIC MILITARY BENCH / O-MB



OLYMPIC SQUAT RACK / O-SR



ADJUSTABLE BENCH / FWMAB



DECLINE/ABDOMINAL BENCH / FW-DB



ADJUSTABLE BENCH WITH DOCK 'N' LOCK / HDU-ADJ-DNL



XL ADJUSTABLE BENCH WITH DOCK 'N' LOCK / HDU-ADJXL



HD ELITE ID BENCH / ELT-ADJN



MULTI-ADJUSTABLE BENCH / HDU-MAB

BENCHES AND RACKS



FLAT BENCH / FW-FB



SEATED ARM CURL / FW-AC



VERTICAL SMITH MACHINE / HSSMV



SMITH MACHINE / HSSM



BACK EXTENSION / BW-BE



CHIN/DIP/LEG RAISE / BW-CDL



FIXED PAD GLUTE/HAM / BW-GHF



GLUTE/HAM / BW-GH



UTILITY BENCH-75° / FW-UB75



BARBELL RACK / FW-BAR



DELUXE WEIGHT TREE / FW-DWT



BUMPER PLATE STORAGE COMPACT / FW-BPC



BUMPER PLATE STORAGE SMALL / FWBPS LARGE / FW-BPL



DUMBBELL RACK-SINGLE / FW-DR1



DUMBBELL RACK-DOUBLE / FW-DR2



DUMBBELL RACK-TRIPLE / FW-DR3



OVERBLOCK ADJUSTABLE DUMBBELL RACK / FW-DRA



MODULAR ACCESSORY STORAGE / FW-MAS



ACCESSORIES

LEGACIES ARE MADE OF HARD WORK AND HARDER STEEL.

Hammer Strength accessories are for facilities that want to create a cohesive performance training experience. A growing portfolio of products lives up to an evolving legacy of world-class athletic and functional training equipment.



HAMMER STRENGTH ACCESSORIES



12-SIDED URETHANE DUMBBELLS



4-SIDED URETHANE DUMBBELLS



ROUND RUBBER DUMBBELLS



RUBBER HEX DUMBBELLS



FIXED BARBELLS



PRO100 ADJUSTABLE DUMBBELLS

OLYMPIC PLATES



12-SIDED URETHANE PLATES



ROUND URETHANE PLATES



ROUND RUBBER PLATES

BUMPERS



URETHANE BUMPER PLATES



PREMIUM RUBBER BUMPERS



STANDARD RUBBER BUMPERS



RECYCLED RUBBER BUMPER PLATES



CERAKOTE BARS

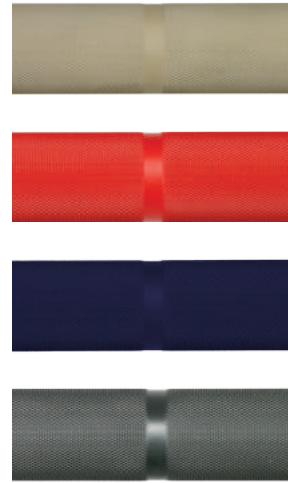

BAR COLLARS



WOOD PLYO BOX 20X24X30"



3-IN-1 SOFT PLYO BOX



STACKABLE PLYO BOXES



BARS



SLAM BAGS



SLAM BALLS



POWER BANDS



COMPETITION KETTLEBELLS



WALL BALLS



STABILITY BALLS



DC BLOCKS



WEIGHT SLED

LIFE FITNESS ACCESSORIES

THE NO. 1 BRAND OF HEALTH CLUB EQUIPMENT WORLDWIDE

For more than 55 years, Life Fitness has been at the forefront of fitness. We offer more fitness equipment choices than any other manufacturer. This carefully selected range of premium fitness accessories addresses the innovative ways people train today and gives you more ways to help exercisers achieve their goals.



KETTLEBELLS



HEAVY BAG



TIRES



MEDICINE BALLS



STABILITY BALLS



RESISTANCE TUBES

CORE MAT



YOGA MAT



JUMP ROPE



STUDIO DUMBBELS



PLYO BOX

YOGA BLOCK



FOAM ROLLER



CORE BAGS



ADJUSTABLE HURDLES



SPEED CONES



SPEED LADDER

Images not to scale. Products subject to change.





BE READY

ACFT EQUIPMENT

Life Fitness offers a variety of ACFT-compliant accessories to help our service members be prepared for any situation. These tools are developed to support training that reflects real-life situations. Our ACFT products can be purchased as a single-lane set—with the components needed to train for or take the Army Combat Fitness Tests—or they can be purchased individually.

LifeFitness HAMMER STRENGTH

ACFT EQUIPMENT



PULL UP STAND



SPRING COLLARS



HEX BAR



NYLON SLED



MEDICINE BALL



RECYCLED RUBBER BUMPER PLATES



CAST-IRON KETTLEBELLS



TAPE MEASURE

ACFT EQUIPMENT

PREMIUM EQUIPMENT. WORLD-CLASS SERVICE.



WE UNDERSTAND THE COST OF FACILITY DOWNTIME, SO WE'VE CREATED THE LEADING SERVICE AND SUPPORT PROGRAM IN THE INDUSTRY.

We have 55 Life Fitness service technicians, 60 call center agents, and more than 300 certified independent service operators in the field. This support network is why Life Fitness has earned a reputation as the world's most reliable fitness equipment supplier.

Contact the Life Fitness Service Team
800.494.6344 (option 3)
customersupport@lifel FITNESS.com

LIFE FITNESS SERVICE PARTS WEBSITE

24-hour access to replacement parts for all of our fitness equipment. Easily find the parts you need by entering the serial number for the piece of equipment that requires service.

LifeFitness.com/parts
800.351.3737
847.288.3700 (international)

STRENGTH EQUIPMENT COLOR CHART

STRENGTH FRAME COLORS	LIFE FITNESS	HAMMER STRENGTH	HD RACKS	
			NX & ID	HD ATHLETIC PRO BRIDGE AND RIG
			NX Xmember are HW Charcoal Only	Upright & Xmember
Platinum*	S	S	S	N/A
Black	S	s	N/A	N/A
Charcoal	S	S	s	N/A
Titanium**	S	S	s	N/A
White	S	S	s	N/A
Blue	O	S	s	N/A
Red	O	S	s	N/A
Yellow	O	S	s	N/A
Midnight Metallic*	O	O	C	N/A
Mocha Sand	O	O	C	N/A
Candy Apple Red	O	N/A	N/A	N/A
Diamond White Clear	O	N/A	N/A	N/A
Electric Blue	O	N/A	N/A	N/A
High Wear Charcoal	C**	C	s	S
High Wear Platinum	C**	C	s	S
Matte High Wear Titanium	C**	C	s	S
Matte High Wear White	C**	C	s	S
Matte High Wear Yellow	C**	C	s	S
Matte High Wear Red [^]	C**	C	s	S
Matte High Wear Blue [^]	C**	C	S	S
Custom	C**	C	C	C

Key:
S = Standard
O = Optional
C = Custom
N/A = Not Available

Notes:
 * Life Fitness colors have a second clear coat of paint
 ** Custom frame colors not available on Life Fitness Benches and Racks, Axiom or Circuit Series
 # Hammer Strength Select and MTS have a second clear coat of paint
 ^ Colors do not match original High-Wear Red and High-Wear Blue
 New custom frame colors require a one-time Custom Formulation Set-Up fee



NOTES

NOTES

LifeFitness

**HAMMER
STRENGTH®**

UNITED STATES, CANADA, LATIN AMERICA

LIFE FITNESS WORLD HEADQUARTERS

9525 W. Bryn Mawr Ave.

Rosemont, IL. 60018

Tel: 800.494.6344

Tel: +1.847.288.3440

Fax: 847.789.8506

[LifeFitness.com](https://www.LifeFitness.com)

©2023 Life Fitness, LLC. All Rights Reserved. Life Fitness and Hammer Strength are registered trademarks of Life Fitness, LLC and its affiliated companies and subsidiaries. Brunswick and related trademarks used under license from Brunswick Corporation. Apple and Apple Watch are registered trademarks of Apple, Inc. Bluetooth is a registered trademark of Bluetooth SIG, Inc. Android is a trademark of Google, Inc. Jacobs Ladder is a trademark of Jacobs Ladder, LLC.USV-004-23

